

# Acer p700 Series Portable Navigator



Copyright © 2007. Acer Incorporated.  
All Rights Reserved.

Acer p700 Series Portable Navigator User Guide  
Original Issue: July 2007

Changes may be made periodically to the information in this publication without obligation to notify any person of such revisions or changes. Such changes will be incorporated in new editions of this User's Guide or supplementary documents and publications.

Record the model number, serial number, purchase date and place of purchase information in the space provided below. The serial number and model number are recorded on the label affixed to your handheld. All correspondence concerning your unit should include the serial number, model number, and purchase information.

No part of this publication may be reproduced, stored in a retrieval system, or transmitted, in any form or by any means, electronically, mechanically, by photocopy, recording or otherwise, without the prior written permission of Acer Incorporated.

### Acer p700 Series Portable Navigator

Model number: \_\_\_\_\_

Serial number: \_\_\_\_\_

Date of purchase: \_\_\_\_\_

Place of purchase: \_\_\_\_\_

Acer and the Acer logo are registered trademarks of Acer Incorporated. Other companies' product names or trademarks are used herein for identification purposes only and belong to their respective companies.

Microsoft, ActiveSync, Outlook, Pocket Outlook, Windows, Windows NT and the Windows logo are either registered trademarks or trademarks of Microsoft Corporation in the United States and/or other countries. Microsoft products are licensed to OEMs by Microsoft Licensing, Inc., a wholly owned subsidiary of Microsoft Corporation.

Acer and its subsidiaries make no representations or warranties, either expressed or implied, with respect to the contents hereof and specifically disclaims the implied warranties of merchantability or fitness for a particular purpose. Acer and its subsidiaries assume no responsibility for any damage or loss resulting from the use of this Acer p700 Series Portable Navigator User Guide.

## Disposal instructions

---

Do not place this product on an unstable cart, stand or table. If the product falls, it could be seriously damaged.

This product should be operated from the type of power indicated on the marking label. If you are not sure of the type of power available, consult your dealer or local power company.

Do not allow anything to rest on the power cord. Do not locate this product where people will walk on the cord.

If an extension cord is used with this product, make sure that the total ampere rating of the equipment plugged into the extension cord does not exceed the extension cord ampere rating. Also, make sure that the total rating of all products plugged into the wall outlet does not exceed the fuse rating.

Never push objects of any kind into this product through cabinet slots as they may touch dangerous voltage points or short-out parts that could result in a fire or electric shock. Never spill liquid of any kind onto or into the product.

Do not attempt to service this product yourself, as opening or removing covers may expose you to dangerous voltage points or other risks. Refer all servicing to qualified service personnel.

Unplug this product from the wall outlet and refer servicing to qualified service personnel under the following conditions:

- When the power cord or plug is damaged or frayed.
- If liquid has been spilled into the product.
- If the product has been exposed to rain or water.
- If the product does not operate normally when the operating instructions are followed. Adjust only those controls that are covered by the operating instructions, since improper adjustment of other controls may result in damage and will often require extensive work by a qualified technician to restore the product to normal condition.
- If the product has been dropped or the case has been damaged.
- If the product exhibits a distinct change in performance, indicating a need for service.

The Acer p700 Series Portable Navigator uses a lithium battery. Replace the battery with the same type as the product's battery we recommend in the product specification list. Use of another battery may present a risk of fire or explosion.

**Warning!** Batteries may explode if not handled properly. Do not disassemble or dispose of them in fire. Keep them away from children and dispose of used batteries promptly.

To avoid hazard of unexpected electrical shock, use the AC adapter only when the wall socket is properly grounded.

Do not use your device while exercising.

## Acer p700 Series Portable Navigator feature highlights

No more fumbling with wieldy, outdated paper maps. No more sheepish "I think I'm lost" expression. And most definitely, no more going in circles finding that particular spot. Get to your destination the fast and easy way with your new Acer p700 Series Portable Navigator.

### **Powerful system**

- Microsoft Windows CE version 5.0 operating system
- Samsung 266 MHz processor
- SiRF Star III LP chipset and firmware solution
- Rechargeable 1100 mAh Lithium ion battery

### **Wide and accurate GPS coverage**

- Intuitive and intelligent navigation software
- Integrated chip antenna for optimum satellite pick up

### **Mobile design**

- Compact and lightweight body makes it easy for you to carry it anywhere while driving or hiking
- Car mount kit for multi-vehicle usage
- On-the-road recharging options via the car charger

### **Battery life**

- Normal usage: 3.5 hours
- Navigation software usage: 2.5 hours

Ergonomic features

- 4.3-inch WQVGA touch-sensitive LCD screen
- Accessible control hotkeys with backlight illumination
- Simple, easy-to-use user interface with large icons and command buttons
- Multi-language user interface
- Advanced power-saving options

Multimedia programs

- **Photo** for your favorite digital pictures

**Contact** management program

- **Contacts** for managing contact information on your device

**Bluetooth Program**

- **Bluetooth** for selected models only: p760 and p780
- Making and receiving phone calls

## Unpacking the Acer p700 Series Portable Navigator

Thank you for purchasing the Acer p700 Series Portable Navigator. The Acer p700 Series Portable Navigator box contains all of the items listed below.

- Acer p700 Series Portable Navigator unit



- Car mount kit

Car mount

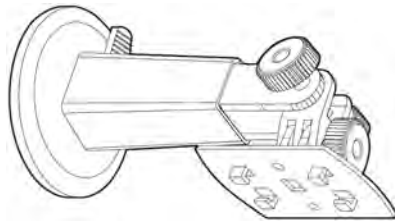

Device holder

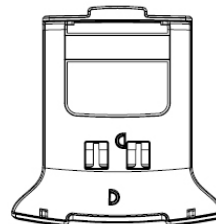

**Chargers**

- Car charger



- Wall charger for p700 Series

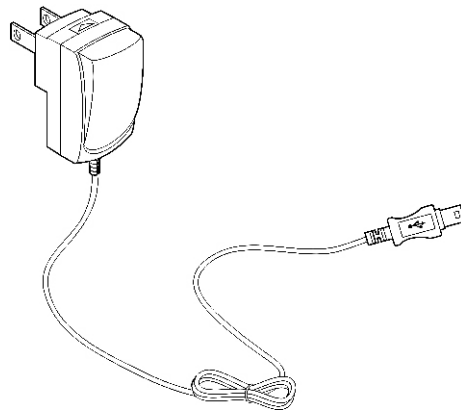

- Mini USB transfer and charge cable

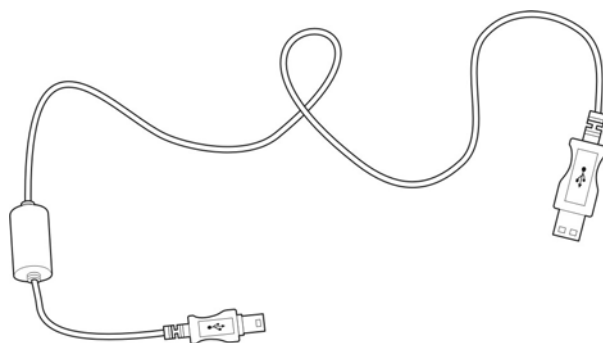



- Navigation software SD card (Manufacturer option)



- User Documentation
  - Acer p700 Series Portable Navigator CD
  - TMC ready for p700 Series Portable Navigator Getting Started Guide
  - Acer p700 Series Portable Navigator Warranty Booklet
  - Navigation software Quick Starter Guide
  - Navigation software CD
  - User can purchase Acer TMC upgrade kit for p710 to enable the TMC function.
  - P730/p760/p780 already bundle TMC receiver in the package.

---

NOTE: Report any product defects or missing items to the place of purchase immediately. Save the boxes and packing materials for future use.

Some models may include optional accessories that might not be shown in the above illustrations. Please check with your dealer for more details.

---

# First things first

---

This chapter describes the hardware interface of the Acer p700 Series Portable Navigator and its peripherals. Instructions for setting up the device and some basic system operations are also discussed.

## System tour

This section gives you a tour of the device hardware interface.

### Front and rear panels

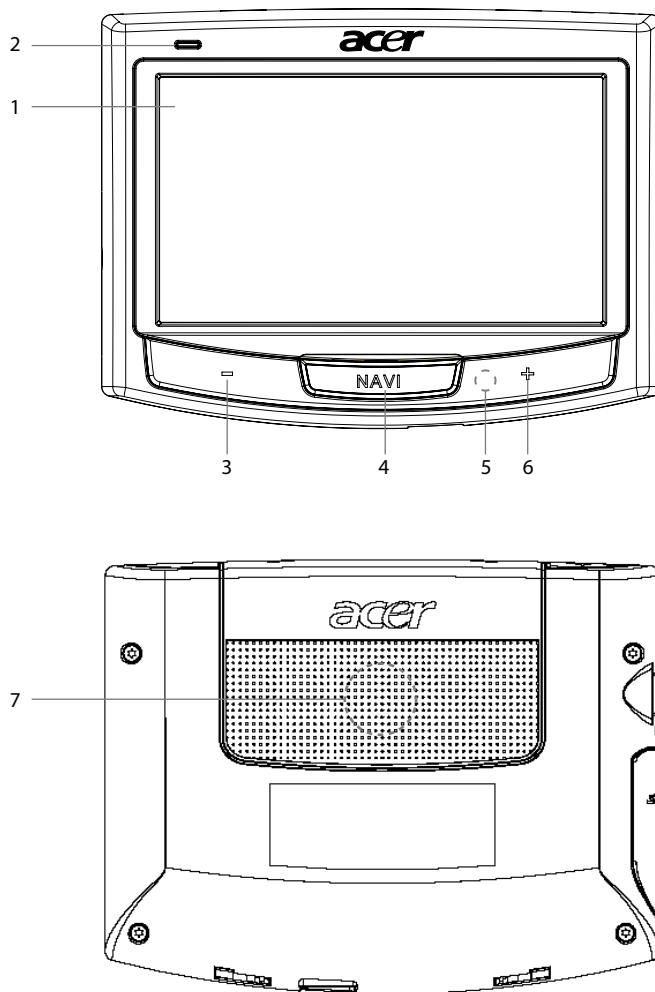

No	Icon	Component	Description
1		Touch screen	Displays the applications, data, and map images available on your device. It is touch sensitive and responds to finger taps.
2		Power status LED indicator	Indicates the battery charging status. <ul style="list-style-type: none"><li>• Green – Battery is fully charged</li><li>• Orange – Battery charging</li><li>• Red – Battery low</li></ul>
3	—	Volume down button	Decreases speaker volume.
4	NAV	Navigation button	Pressing this button wherever you are, panel will bring you to the Navigation panel.
5		Microphone	Internal microphone is used during phone communication.
6	+	Volume up button	Increases speaker volume.
7		Speaker	Emits system sounds.



---

NOTE: For more information on how to use your Acer p700 Series Portable Navigator in navigation mode, refer to the Navigation software Quick Starter Guide or the Navigation software User's Guide (located on the Navigation software DVD).

---

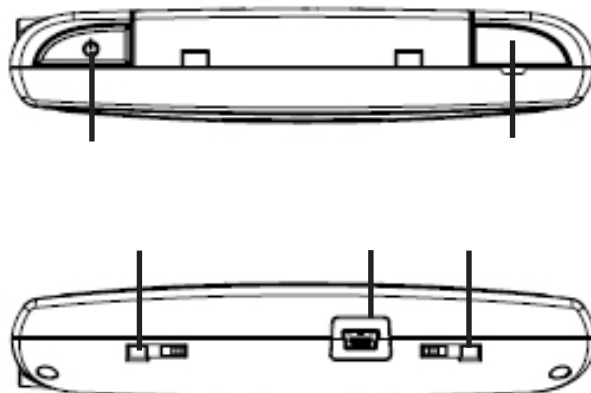

## Top and bottom views

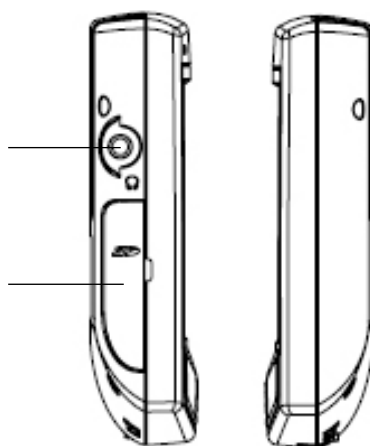

No.	Icon	Component	Description
1		GPS antenna jack	Connects to an external GPS antenna.
2		Power button	Switches the device into standby mode.
3		Soft reset button	Used to do a soft reset of the device. For more information, see "Performing a soft reset" on page 34.
4		USB port / Docking connector (Manufacture option)	For USB port: connects the device to computer running on the Microsoft Windows platform. Also serves as the power connector for charging the device. Connects to external TMC module (Selected models only). For Docking connector: connects to car mount kit.
5		Power switch	Used to switch device on initially, or to do a hard reset of the device. For more information on performing a hard reset, see "Performing a hard reset" on page 63.

## Left and right panels



No.	Icon	Component	Description
1		Earphone jack	Connects to earphones/headphones.
2		SD/MMC slot	Accepts SD and MMC storage cards, allowing you to use audio, image, and map files stored in it for use with internal applications.

## Peripherals tour

This section gives you a tour of the peripherals bundled with your Acer p700 Series Portable Navigator.

### Car mount kit

The car mount kit consists of the car mount and the device holder.

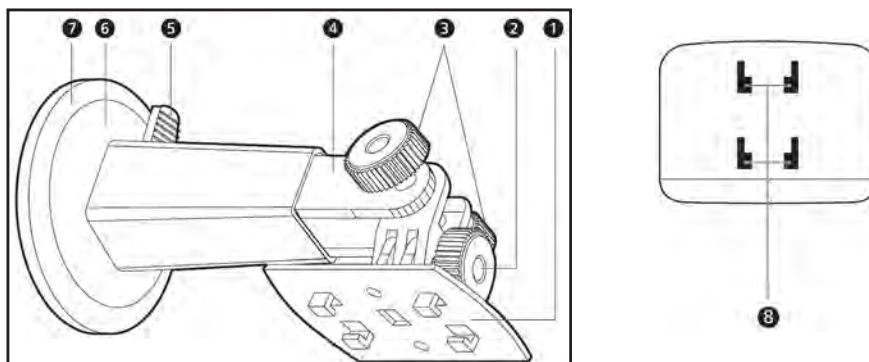

No.	Component	Description
1	Holder plate	connects the car mount to the holder.
2	Horizontal angle adjustment knob	Slightly loosen the knob to adjust the viewing angle in a left-right direction.
3	Vertical angle adjustment knobs	Slightly loosen the knobs to adjust the viewing angle in an up-down direction.
4	Extendable rod	Extend the rod to adjust the device position in a front-to-rear direction.
5	Suction cup locking lever	Secures the vacuum seal of the car mount.
6	Suction cup	Fixes the car mount on the selected mounting area.
7	Suction cup release tab	Pull to release the vacuum seal of the suction cup.
8	Car mount holes	Accepts the pegs on the holder plate of the device mount.

## Acer p700 Series Portable Navigator setup

Using your new Acer p700 Series Portable Navigator for the first time is a snap. Unpack, turn on, mount and you're ready to go. Perform the following easy installation tasks to start using the device straight out of the box:

- 1       Unpack the device
- 2       Set up the device in your vehicle and push the power button at the top to power on the device.

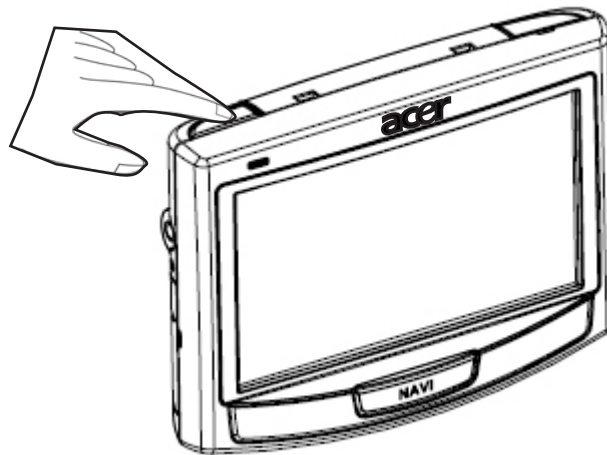

## Setting up the Acer p700 Series Portable Navigator in your vehicle

The Acer p700 Series Portable Navigator comes with a car mount kit and a car charger with which you can set up your device in your vehicle. You can choose to position the car mount kit on the windshield using the suction cup, or on the dashboard using the self adhesive disc.

**CAUTION:** Some countries prohibit the mounting of any electronic device in any location on the vehicle dashboard. Be sure to check your local laws for acceptable mounting areas before installing the car mount bracket.

**NOTE:** Some newer vehicle models may have a heat reflective shield embedded in the windshield. This may in some cases obstruct the GPS signal reception. If you encounter this problem in your vehicle, you need to purchase an external GPS antenna. For more information, contact your local Acer dealer.

### Car mount installation reminders

Install the car mount on a surface of your vehicle:

- That is smooth, flat and free of dirt and oil
- Where you can easily view/reach it without taking your eyes too far off the road.
- Where the device will not obscure car controls nor restrict your view of the road.
- Far from the air bag deployment area.

### To setting up the device on your vehicle

This section shows how to install the car mount kit on your vehicle's windshield using the suction cup. For dashboard installation procedures using the self adhesive disc refer to the Acer p700 Series Portable Navigator Getting Started Guide.

- 1 Clean the mounting surface with a glass cleaner and a clean cotton cloth.
- 2 If the ambient temperature is below 15 °C (60 °F), warm the mounting area and the suction cup (e.g. with a hair dryer) to ensure a strong suction bond .
- 3 Install the car mount on the selected area.
  - Fix the suction cup to the selected area with the locking lever facing up.
  - Flip the locking lever away from you to create a vacuum between the suction cup and the mounting surface.



## Starting up the Acer p700 series Portable Navigator

Before mounting the Acer p700 Series Portable Navigator on your vehicle, you should first calibrate the screen. After screen calibration, proceed to configure system settings. To turn on and calibrate the device:

- 1 When you first turn on your device, you will be asked to calibrate the screen. This process ensures that when you tap the screen the item tapped is activated.



- 2 Follow the instructions on the screen. After calibrating the screen, please follow below steps to configure system settings.

Step 1: Language Setting Tap the right arrow beside the Text and choose the language you prefer.



Step 2: Date/Time/Time Zone Settings Tap Date.

- Tap + or - beside the Year, Month, and Day settings to set the date values. Tap Time.
- Tap + or - beside the Hour and Minute settings to set the time values. Tap Time Zone.
- Tap the down arrow beside the Time Zone until the time zone of your choice is displayed.

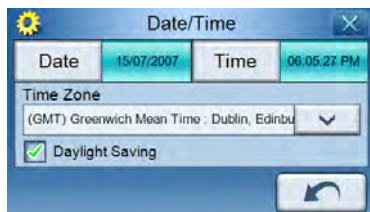

Step 3: Password Settings  
After Date/Time/Time Zone settings is done, below screen will pop up.

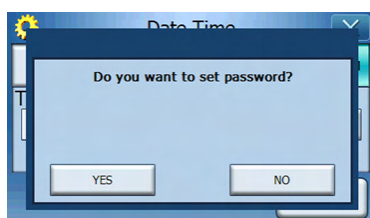

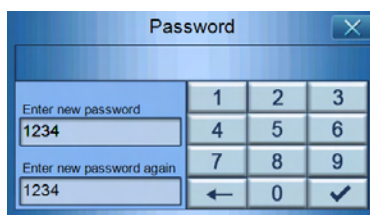

Tap YES button  to set up your password as screen below.



Step 4: Bluetooth phone Settings  
Tap YES for Bluetooth settings or tap NO to abort the setting and go on next step.

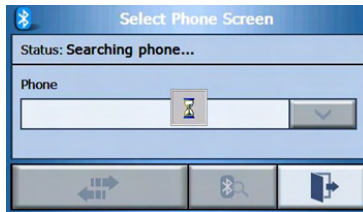



Select the desired mobile phone from the list (tap the down arrow to display the full list) and then tapping  to pair with the phone.



Select the mobile phone that being detected by tapping  down arrow then tapping to connect it.



Step 5: Navigation Settings  
After completing the Bluetooth settings, the Navigation Settings screen will open.



Tap the arrows beside "Choose a Language" and "Choose a Voice" to select your preferred choice.

## Start up the Acer p700 Series Portable Navigator

---



Tap the circle beside “KM” or “Mile” as your preferred choice.

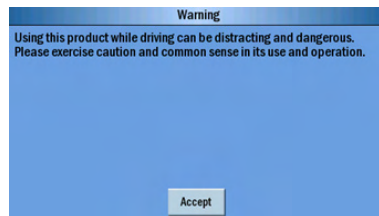

Tap “Accept” after read through the warning message. Below screen will pop up after navigation setting is done.



For more information on the rest of the system configuration options, go to “Systems” on page XX.

Congratulations! Your new Acer p700 Series Portable Navigator is now ready for use. Proceed to “Acer p700 Series Portable Navigator fundamentals” on page 1 for more information on the device’s user interface or you can refer to the Navigation software Quick Starter Guide to start using the device in navigation mode.



# Contents

---

Disposal instructions . . . . .	ii
Important safety instructions	
Acer p700 Series Portable Navigator feature highlights . . . . .	iii
Unpack the Acer p700 Series Portable Navigator . . . . .	v

## First things first

System tour . . . . .	viii
Front and Rear Panels . . . . .	
Top and bottom views . . . . .	
Left and right panels . . . . .	
Peripherals tour . . . . .	x
Car mount kit . . . . .	
Chargers . . . . .	
Acer p700 Series Portable Navigator setup . . . . .	xi
Set up the Acer p700 Series Portable Navigator in your vehicle . . . . .	xii
Car mount installation reminders . . . . .	
To set up the device on your vehicle . . . . .	
Start up the Acer p700 Series Portable Navigator . . . . .	xiii

## 1 Acer p700 Series Portable Navigator fundamentals

Hardware interface . . . . .	4
Using the touch screen backlight . . . . .	
Using the SD/MMC slot . . . . .	
Establishing device-PC connection . . . . .	6
Recharge the device via the USB connection . . . . .	
Recharging the Acer p700 Series Portable Navigator . . . . .	
To recharge the device using the car charger . . . . .	
To recharge the device using the USB cable . . . . .	
Main Menu Screen . . . . .	9
Command interface . . . . .	
Using the hot keys . . . . .	
Using the Acer p700 Series Portable Navigator touch screen . . . . .	
Using the Main menu panel . . . . .	

## 2 Phone

Accessing the Phone Function . . . . .	12
--	----

3 Application . . . . .	13
-------------------------	----

# Contents

---

- i) Photo Viewer** . . . . . 15
  - Accessing the Photo Viewer . . . . .
  - Using the Photo Viewer . . . . .
  - Viewing photos . . . . .
  - Viewing a Photo Full Screen . . . . .
  - Viewing a Slideshow . . . . .
  - Copying Photos . . . . .
  - Deleting photos . . . . .
- ii) Contacts** . . . . . 17
  - Accessing Contacts . . . . .
  - Managing Contacts . . . . .
    - Creating a New Contacts . . . . .
    - Editing a contact . . . . .
    - Deleting a contact . . . . .
  - Importing / exporting / sending contacts . . . . .
    - Importing . . . . .
    - Exporting . . . . .
    - Sending the Contact Information to Another Device . . . . .

## 4 System

- 1. Accessing the System Settings Screen . . . . . 23
- 2. Setting the Volume . . . . .
- 3. Choosing the Language . . . . .
- 4. Adjusting the Settings . . . . .
- 5. Setting the Date / Time . . . . .
- 6. Changing the Time Zone . . . . .
- 7. Choosing Daylight Saving . . . . .
- 8. Changing the Date . . . . .
- 9. Changing the Time . . . . .
- 10. Power . . . . .
- 11. Standby Settings . . . . .
- 12. Backlight . . . . .
- 13. Calibration . . . . .
- 14. Factory Default . . . . .
- 15. System Information . . . . .

## 5 Bluetooth Phone

- Bluetooth Options . . . . . 32

# Contents

---

- Resetting the Acer p700 Series Portable Navigator
  - Performing a soft reset . . . . . 42
  - Performing a hard reset . . . . .
  - Loading the factory default settings . . . . .
  
- Regulatory and safety notices
  - FCC notice . . . . . 44
  - Notice: Peripheral devices . . . . .
  - Caution . . . . .
  - Operation conditions . . . . .
  - Notice: Canadian users . . . . .
  - Remarque à l'intention des utilisateurs canadiens . . . . .
  - Declaration of Conformity for EU countries . . . . .
  - LCD pixel statement . . . . .
  - Radio device regulatory notice . . . . .
  - General . . . . .
  - List of applicable countries . . . . .
  - The FCC RF safety requirement . . . . .
  - Canada — Low-power license-exempt radio communication devices (RSS-210) . . . . .
  - Exposure of humans to RF fields (RSS-102) . . . . .
  
- FAQs . . . . . 45
  
- Customer support
  - Product warranty . . . . . 48
  
- System specifications
  - Hardware features . . . . . 49
  - Software specifications . . . . .
  - Design and ergonomics . . . . .
  - Environmental specifications . . . . .



# 1 Acer p700 Series Portable Navigator fundamentals

---

This chapter describes basic hardware procedures in using your Acer p700 Series Portable Navigator. Information on the device's command interface is also discussed.

## Hardware interface

### Using the touch screen backlight

Under some lighting conditions, viewing the information on your device may be difficult. If this is the case, activate the backlight by tapping on the screen to illuminate the touch screen.

### Using the SD/MMC slot

Your Acer p700 Series Portable Navigator has an SD/MMC slot compatible with a range of SD and MMC storage cards.

Also, the Acer p700's GPS navigation system has its core on the Navigation software program. Using this program requires you to load the digital maps available on the Navigation software SD card included with the device (SD card is included with certain models only).

## Acer p700 Series Portable Navigator fundamentals

### Hardware interface

---

#### Inserting an SD / MMC card

- 1 Hold the device securely; and push the card into the slot until you hear an audible system sound; this will signal that the card is already properly seated within the slot. The card is secure when it is not protruding from the slot.

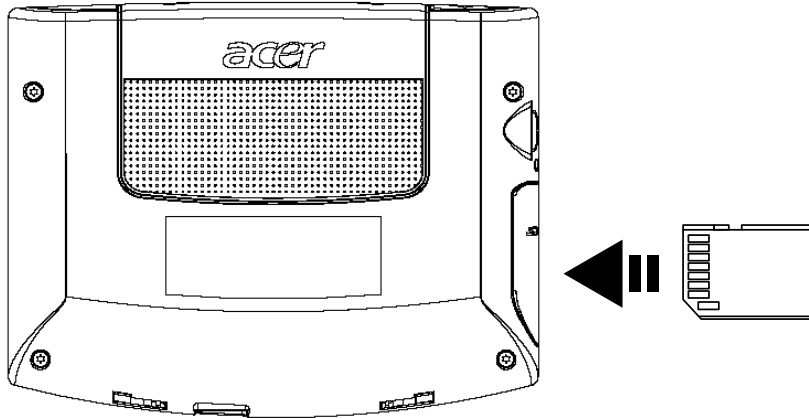

#### Remove a storage card

- 1 Hold the device securely; and push against the top of the card, as if you were pushing it further into the slot, letting the card spring out. An audible system sound will signal that the card has been released.
- 2 Gently remove the card from the slot.

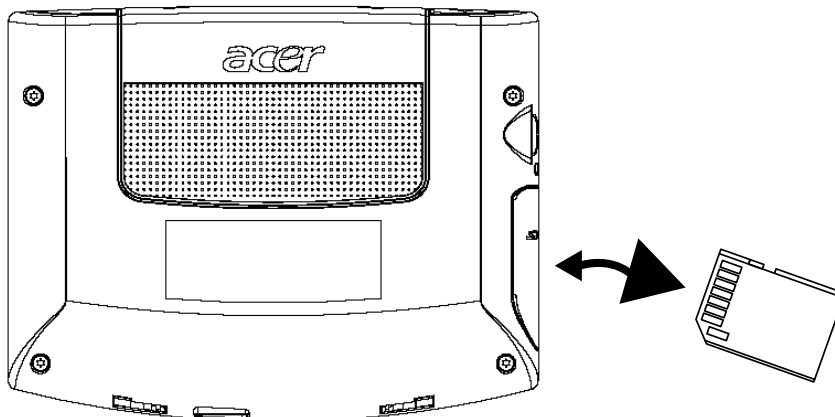

## Establishing a device-PC connection

The USB cable that comes with your device enables you to connect the device to your computer.

### Recharge the device via the USB connection

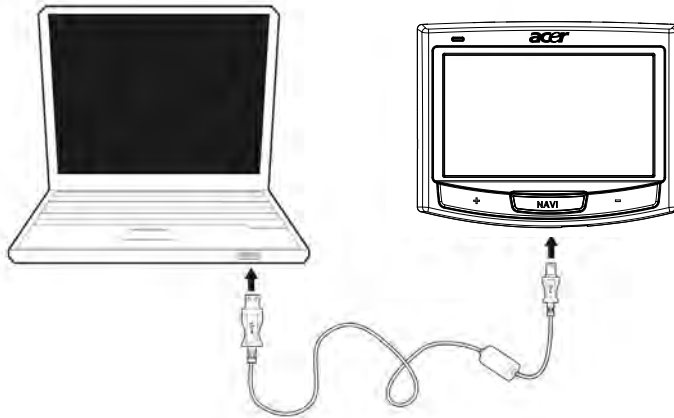

Enable SD/MMC card as Mass Storage.  
Access data from SD/MMC card which plugged in into device.

---

NOTE: SD/MMC card must be plugged in into device for operating device and making Mass Storage enable.

---

#### Minimum installation requirement:

- Microsoft Windows XP, 2000 and ME
- Available USB port
- CD-ROM drive
- VGA graphics card compatible video

## Recharging the Acer p700 Series Portable Navigator

Your Acer p700 Series Portable Navigator uses a rechargeable 1100 mAh Lithium ion battery. The status icon located on the top right corner of the Main Menu panel indicates the level of the device's battery power.

If the battery level becomes low in the course of normal use, recharge the device. Normally, you can use the wall charger to recharge your device.

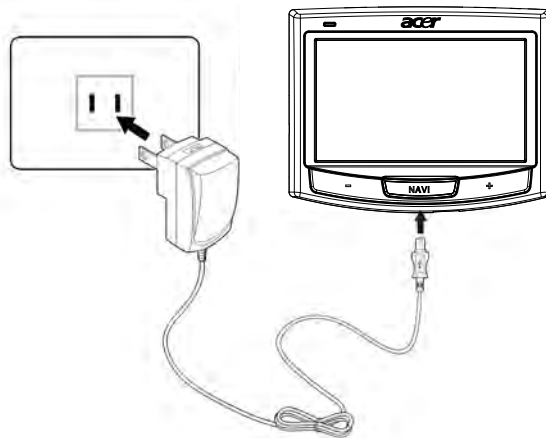

You can use the Mini USB Sync cable to recharge your Acer p700 series from a computer, or the car charger cable bundled with your device. Recharging time varies depending on type of charge, but a charge from empty to full capacity is typically at about 3.5 hours.

---

**NOTE:** If the battery level reaches very low status, the device will automatically turn off. In this case, you have about 12 hours to recharge your device after which you risk losing all data on the device's internal memory. In case all data is lost, the next time you switch on the device you will be prompted to restore the data.

Certain models can only be used with external power. In this case, your device should be connected to external power (car charger, wall charger, etc) at all times when being used.

---

Acer p700 Series Portable Navigator fundamentals  
*Recharging the Acer p700 Series Portable Navigator*

---

**Recharging the device using the car charger**

Use the car charger to recharge your device while it is mounted on your vehicle.

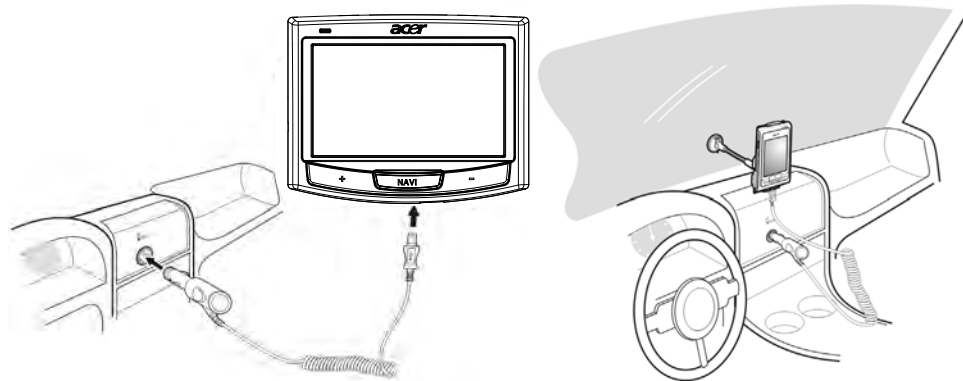

**Recharging the device using the USB cable:**

The Mini USB Sync and charge cable that comes with your device enables you to connect your device to a computer running on the Microsoft Windows platform. When connected, the device battery is also recharged via the USB connection. Go to the "Establishing a device-PC connection" on page 6 for instructions on how to connect your Acer p700 Series Portable Navigator to a computer.

## Main Menu screen

### Command interface

#### Using the hotkeys

The hotkeys on your Acer p700 Series Portable Navigator allow you to:

- **+/-** – Control the volume level of sound from the speaker/earphones
- **NAVI** – Enter Map Screen

#### Using the Acer p700 Series Portable Navigator touch screen

The Acer p700 Series Portable Navigator touch sensitive screen allows for a more natural way of entering information into the device using fingers instead of a stylus - no more wasted time finding a lost stylus or fumbling with an awkwardly shaped one! for the Acer p700 series, the tap and hold-and-drag actions are done by:











- **Tap** – Touch the screen once to open items and select options.
- **Hold and drag** – Tap a slider icon and drag it across the screen.

## Using the Main Menu screen

When you switch on your device for the first time each day, you'll see the Map Screen screen, also called the Home screen. From any other screen, you can revert to it by pressing the hotkeys NAVI.

The Main Menu title bar displays the battery power level status icon. Go to the "Recharging the Acer p700 Series Portable Navigator" on page 5 for more information on this status icon.

There are ten program icons on the Main Menu panel.

- |   |  |
|---|--|
|    | Tap to display the Destination Menu. Refer to the Navigation software.                               |
|    | Tap to personalise your navigation settings.   |
|    | Tap to program CoPilot to make a detour a part of the calculated route.                              |
|    | Tap to choose from six different screen display options.   |
|  | Tap to show Phone Menu.  |
|  | Tap to display the TMC Menu, refer to the Navigation Software.                                       |
|  | Tap to plan or edit trip with multiple destinations.   |
|  | Tap to set up your map preferences.  |
|  | Tap to launch Photo for picture mode operation or the Contacts program to access your contacts list. |
|  | Tap to adjust the system settings.   |

## Destination

### *Accessing the Destination Function*

---

## Accessing the Destination Function

Switch the unit on and tap Destination in the Main Menu screen.



After the application loads, the main Destination menu will appear.

For more information regarding the Destination function, please see the Navigation software Quick Starter Guide or the software User's Guide.



## 2 Phone

---

### Accessing the phone function

To access the Phone functions:  
Switch the unit and tap Phone in the Main Menu screen.



The Phone Menu will now appear in the display:

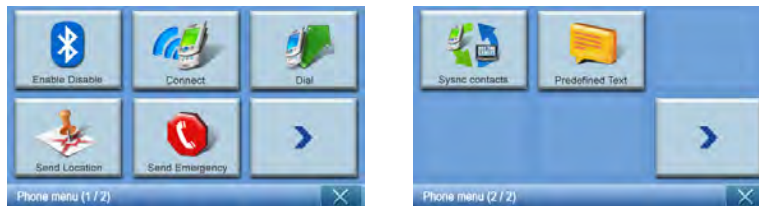

You can access:

**Disable / Enable** - Disable or enable Bluetooth function

**Connect Phone** - Connect phone nearby

**Dial** - Dial out by phone number

**Send Location** - Send the current position by phone

**Send Emergency** - Send the emergency message

**Sync Contact** - Synchronize the Contacts data

**Predefined Text** - Edit message as Short Message Service (SMS)

# 3 Applications

---

## Other available Applications

To access the other available Applications:  
Switch the unit on and tap Application in the Main Menu screen

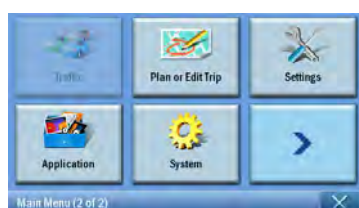

The Application screen will now appear in the display.

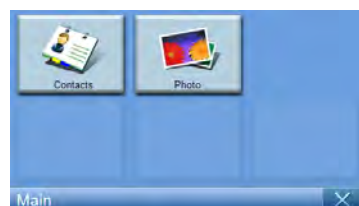

From the screen you can access:  
**Contacts** - Set the detail for contacts  
**Photo** - Display photos

# i) Photo Viewer

---

This chapter describes how to access and use the photo viewer.

## Accessing the photo viewer

Switch the unit on and tap **Photo** in the Main Menu screen.

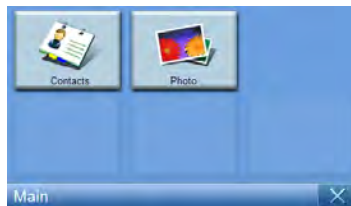

The photo viewer screen will now appear on the display:



## Using the photo viewer

You can view either individual photos or slideshows on your device.

### Viewing photos

If you cannot immediately see the photo thumbnails you are looking for, but see folders, then you can tap those to access their contents.

You can also tap Scroll up  or Scroll down  to search up or down the list of folders or photos.

## Viewing a Photo Full Screen

To view a photo full screen, tap the Full Screen button  .  
Tap anywhere on the screen to quit full-screen display.

## Viewing a slideshow

To start a slideshow, select more than one photo before tapping  . The slideshow will start automatically.  
Tap anywhere on the screen to quit the slideshow.

## Rotating photos

To rotate a photo, tap one photo, tap  , then tap Rotation button  .

## Copying photos

Copying photos function is only enable for p780

To copy a photo or photos from the SD/MMC card to the device, tap which photo(s) you would like to copy and then tap  . You will now see the following screen:

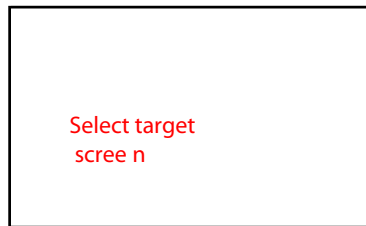

Browse to the place where you would like to paste the photo(s), then tap  again. The photos will then be copied to this place.

## Deleting photos

To delete a photo, tap which photo(s) you would like to delete and then tap  . The photo(s) will then be deleted.

---

NOTE: To deselect a highlighted photo, simply tap it again. You will see that it is no longer highlighted. You can also highlight all images by tapping Select All, or desect all images by tapping Deslect All.

---

NOTE: Photos must be loaded to the SD memory card from your computer. See "Establishing device-PC connection" on page 6 for more information.

---

NOTE: The following file formats can be viewed on your device: BMP, GIF (Still images at least), JPEG.

---

NOTE: To move up one level while browsing, tap  .

---

## ii) Contacts

---

This chapter describes how to manage contact details, including importing, exporting and sending contacts functions. Bluetooth function is only enable for p760 and p780.

### Accessing Contacts

Switch the unit on and tap Contacts in the Main Menu screen.

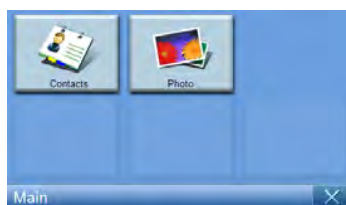

The Contacts screen will now appear in the display:



Scroll up



Scroll down



Import/Export/Send contact



Edit contact



Create new contact



Select All



Deselect All

 Delete contact

---

 Return to Main Menu

---

You can store and edit contact information on your device. You can then use this later to find this contact's address quickly on your GPS navigator. Bluetooth function is only enable for p760 and p780.

## Managing Contacts

### Creating a new contact

To create a new contact, tap the Create new contact button  .  
The following screen will now appear:



 Scroll up

---

 Scroll down

---

 Previous contact

---

 Next contact

---

 Enter Into navigator

---

 Return to Contacts list



Close window

---

Enter the following information for the contact:



- Name
- Family (Last Name)
- Phone
- Mobile
- Street
- City
- State
- Zip
- Country
- Title
- Company
- Email

Also, if you wish this contact to be included in your panic list, tick the **Used for Emergency** checkbox.



If you want to immediately feed this contact's address into your GPS navigator, tap the **Enter into navigator** button . If you have not yet saved the contact information, you may be asked if you wish to do so now.

To leave this screen and return to your list of contacts, tap Return .

## Editing a contact

To edit a contact, tap **Scroll up**  or **Scroll down**  to highlight a contact, then tap **Edit** .

## Deleting a contact

To delete a contact, tap Scroll up  or Scroll down  to highlight a contact, then tap Delete .

## Importing/exporting / sending contacts

### Importing

To import or export a contact, tap the **Import/Export contact** button  from the main contacts list. You will now see the following screen:

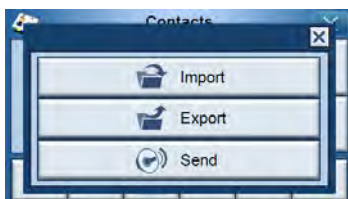

To import a contact from the SD/MMC card to the main memory, tap Import.

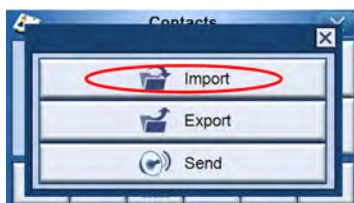

The following screen will now appear:



You can tap each contact to select and tap again will deselect.



Once you have selected the contact(s) you wish to import, tap **Import**  .

## Exporting

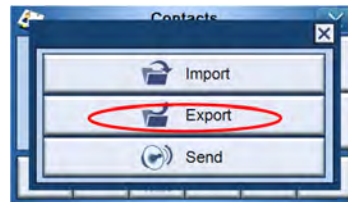

To export a contact from the main memory to the SD/MMC card, tap **Export**.



The following screen will now appear:



You can either

- Tap the checkboxes beside each contact to select (tapping again will deselect), or
- Tap **Select All**  to select all contacts, or
- Tap **Deselect All**  to deselect all contacts.

Once you have selected the contact(s) you wish to export, tap **Export**  .

## Sending the contact information to another device

To send the contact information to another Bluetooth-enabled device, tap **Send**.

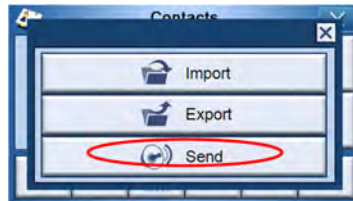

Your device will start to look for other Bluetooth devices that it can send contact information to. Once the search is finished, a list of available devices will be shown, as follows :



Tap the down arrow  to display a drop-down list and choose the device you want to send contact information to. The information will now be sent.

---

NOTE: It may be necessary to enter a pin code on your other Bluetooth device before contact information is sent. If this is the case, then please enter 1111, when asked for a pin code.

---

---

NOTE: Bluetooth function is for selected models only: p760 and p780.

---

# 4 System

---

## Accessing the system setting Screen

To access the Settings feature on your device:  
Switch the unit on and tap **Settings** in the Main Menu screen.

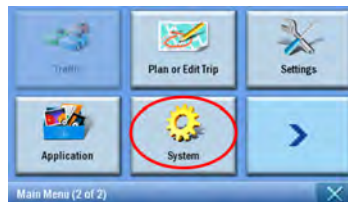

The Settings screen will now appear on the display:

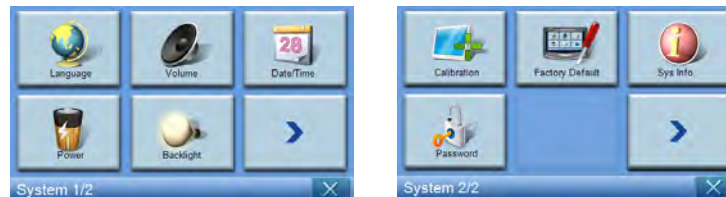

From this screen you can access:

- Language** – Select the default language
- Volume** – Set the default volume
- Date/Time** – Set the date/time
- Power** – Adjust power-saving options
- Backlight** – Adjust the backlight
- Calibration** – Adjust the accuracy for touch panel
- Factory Default** – Back to Factory Default setting
- Sys Info.** – View system information

## Choosing the Language

Tap **Language** on the Settings screen.

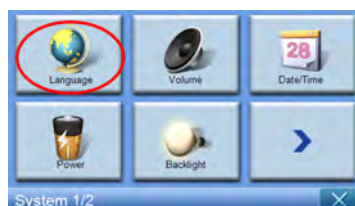

The Language screen will now appear in the display:



- To change the Text language, tap the down arrow  to display a drop-down list of languages, then tap a language from the list .

Once you have finished, tap Back  .

## Adjusting Settings

### Setting the Volume

Tap **Volume** on the Settings screen.

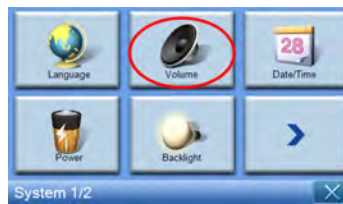

The Volume screen will now appear in the display:

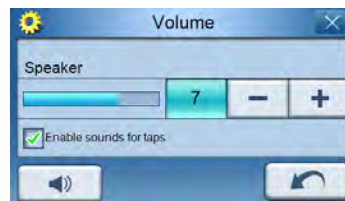

Tap the **+** or **-** buttons to increase or decrease the volume.

(Alternatively, you can use the +/- hotkeys to increase or decrease the volume.)

Check the **Enable sound for taps** option if you would like to hear a clicking sound each time you tap a button.

Once you have finished, tap Back  .

## System Adjusting settings

---

Here you can set how long the device waits before turning off when on battery power only .

Once you have finished, tap Back  .

### Setting the date and time

Tap Date/Time on the Settings screen.

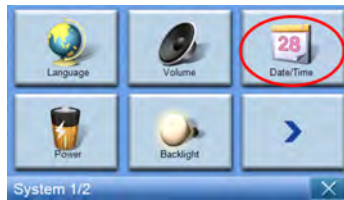

The date and time screen will now appear in the display:

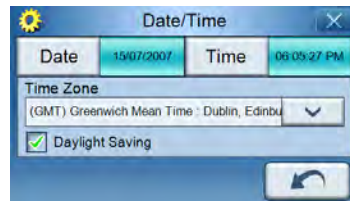

### Changing the time zone

To change the time zone, tap the down arrow  beside Time Zone.

From the drop down list that appears, tap on the time zone you want to use.

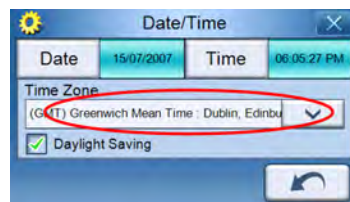

### Choosing Daylight Saving

If you live in an area that uses Daylight Saving (moving the clock forward/back once a year), then make sure that the Daylight Saving checkbox  is checked.

### Changing the Date

To change the date, tap **Date**.

The Date screen will now appear:

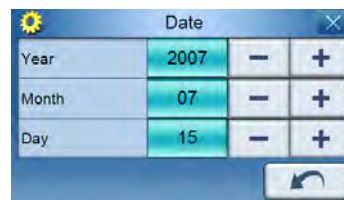

- To adjust the year, tap the + or – buttons beside Year.
- To adjust the month, tap the + or – buttons beside Month.
- To adjust the day, tap the + or – buttons beside Day.

Once you have finished, tap **Back** .

### Changing the time

To change the time, tap **Time** (on the Time/Date screen).

The Time screen will now appear:

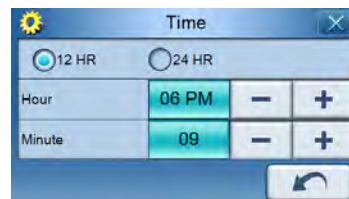

- To choose 24 hour or 12 hour format, tap either the **24HR** or **12HR** radio button .
- To adjust the hour, tap the + or – buttons beside Hour.
- To adjust the minute, tap the + or – buttons beside Minute.

## Power

Tap **Power** on the Settings screen.

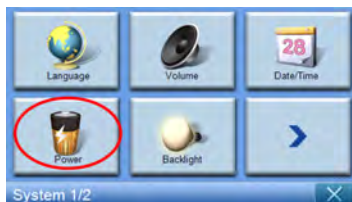

The Power screen will now appear in the display:



- To adjust the brightness, tap the + or – buttons beside Backlight.
- To adjust how long before the backlight turns off while using external power, tap the + or – buttons beside Battery.
- To adjust how long the backlight will stay on while using external power, tap the + or – buttons beside AC Power.



Once you have finished, tap **Back** .

## Backlight

Tap **Backlight** on the System screen.

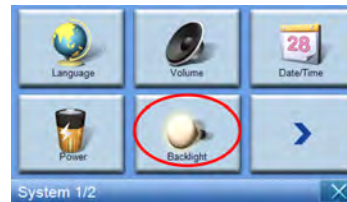

The Backlight screen will now appear in the display:

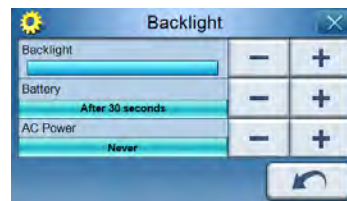

## Caliberation

Tap Calibration on the settings screen.

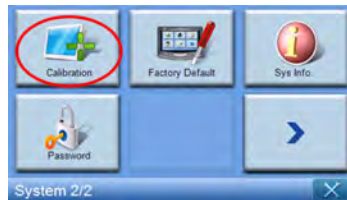

To recalibrate the screen, tap the black dot on the screen to calibrate the device.



## Factory Default

Tap Factory Default on the system screen to reset your device back to factory default settings.

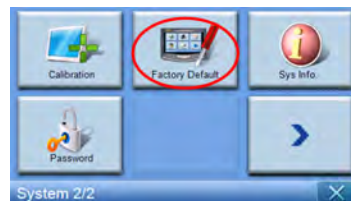

## System information

Tap **Sys Info** on the Settings screen.

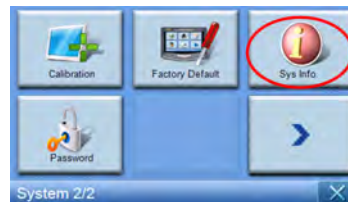

The System Info screen will now appear on the display:



Here you can see your device's Product ID, OS Version, AP Version, Serial Number, GPS firmware version, PCB Version, Bluetooth Address (only displays in p760 and p780), Manufacturer and Copyright statement, trademark & logo (© 2007 Acer Inc.)

To leave this screen, tap Back  .

---

# 5 Bluetooth Phone

---

Bluetooth function is only enable for p760 and p780.

Connecting your mobile phone using Bluetooth

By "pairing" your mobile phone to the p700, you can use the p700 as a handsfree device for added convenience and safety while driving.

Tap the "Phone" icon from the 2nd page of the Main Menu.

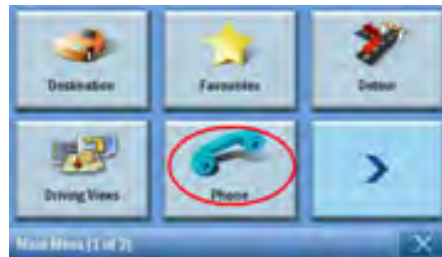

Tap the "Enable" icon . You may have to wait a few seconds while Bluetooth is enabled.

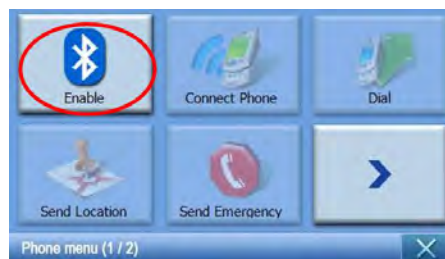

Once Bluetooth is enabled, the grayed out items will be available for selection.

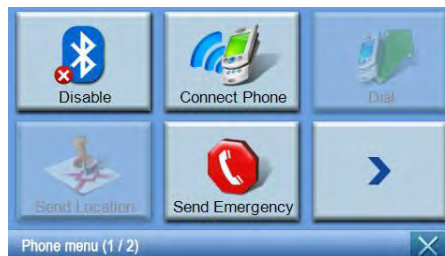

---

Tap the "Connect Phone" icon to start searching for your mobile phone.

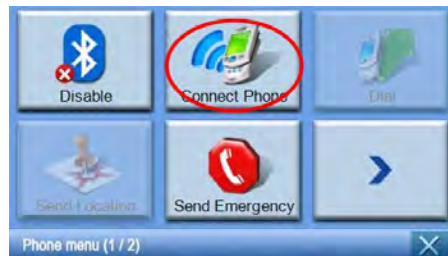

It requires few seconds while searching for your mobile phone.



If there is more than one device detected, use the drop-down menu to select the proper device.



Select the proper device.

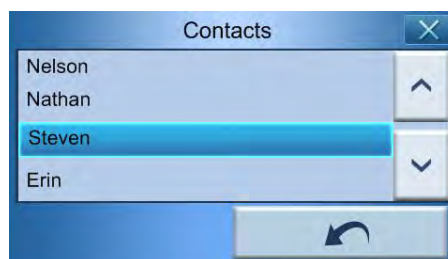

---

Tap the communicate button, the p700 will attempt to connect to your mobile phone.



When prompted, enter "1111" on your mobile phone to complete pairing. (Screen image will vary depending on the model of your phone).



Once pairing is complete, your mobile phone will display a confirmation message.



The p700 will also display a confirmation message.



---

Note: If the confirmation message is not displayed, tap the NAVI button to return to the Bluetooth function screen.

---

Checking the Bluetooth status of your p700

You can check the status via the Bluetooth icon from the main menu, there are 3 status :

#### Description

**Bluetooth disabled** — In this state, Bluetooth is disabled and the handsfree function is not available.

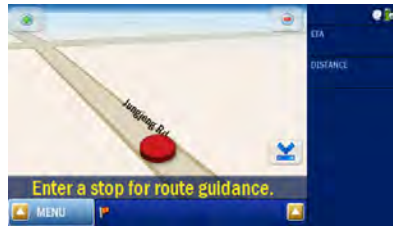

**Bluetooth enabled/phone not connected/paired** — In this state, Bluetooth is enabled but not connected to any mobile phone. You can not make call or receive calls.



**Bluetooth enabled/phone connected** — your P700 is ready to be used to make or receive calls.



#### **Making and receiving phone calls**

After successfully connecting your p700 to your mobile phone, you can start using the p700 as a hands free device. Hands free functionality is available when initiating calls from the mobile phone (recommended) or when initiating calls from the p700. Hands free is also available when receiving calls to your mobile phone.

Tip: Initiate phone calls using your mobile phone, as your phone contacts are already stored there. Tip: While in a call, use the NAVI button to switch between your conversation screen and the previous screen (e.g. Map screen).

---

## How to make a phone call using your mobile phone

Make sure your p700 is correctly paired with your mobile phone, if 2 btn are enable, BT is connect.

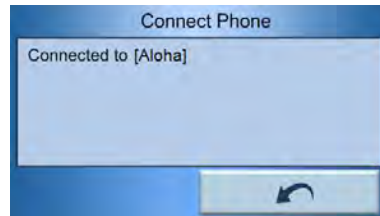

Initiate a phone call using your mobile phone.



Your p700 will display the number being dialed and act as a hands free device.

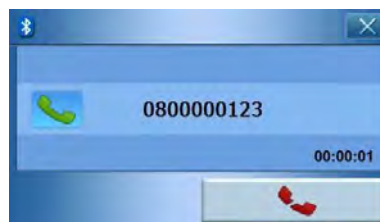

Select  to end the call.

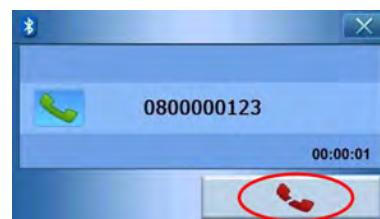



---

Press the NAVI button to return to the Map screen. On the map screen, you can select the phone icon or press the NAVI button to return to the dialing screen.



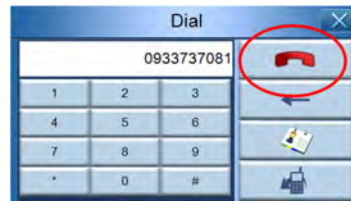

After you finish your conversation, select  to end the call and return to the map screen.



---

## Making a phone call while navigating

Note: The Phone Button  will only be available when Bluetooth is turned on on both p700 and your mobile phone and the phone is successfully connected to the p700. After suspending and resuming your p700 (i.e. switching off/on for short or long time), the Phone Button will not appear unless you receive an incoming call. To make a phone call or access the Phone Button, reconnect your mobile phone to the p700 (refer to the **connecting to your mobile phone using Bluetooth** section above).

Select  on the map screen.



Enter the phone number to dial and select  to initiate the call.



The p700 will dial the number entered.

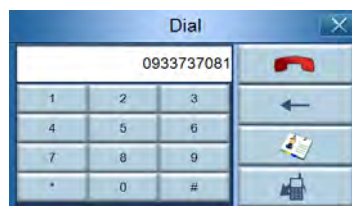

If you want to stop the calling, tap Hang up button . Press the NAVI button to return to the map screen. On the map screen, you can select the phone icon or press the NAVI button to return to the dialing screen.



---

## Answering an incoming call while navigating

When navigating, you will be able to accept incoming calls using your p700 as a hands free phone.

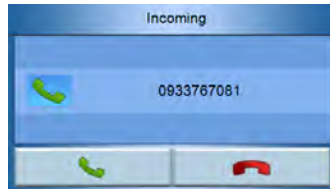

When a call is received, you will see the following screen

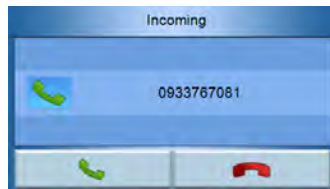

Select Answer  to answer the incoming call.

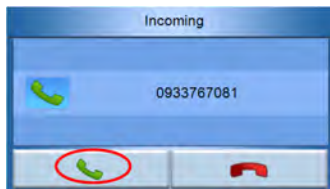

Or select  to reject the incoming call.

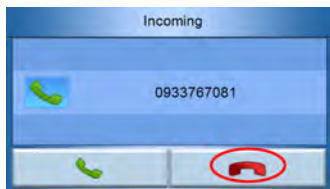

---

After you accept an incoming call, use your p700 as a hands free device.



During a call, press the NAVI button to switch between your phone screen and the map screen. Your conversation will continue.



Select  to end the call. If necessary, switch to the conversation screen using the NAVI button first.

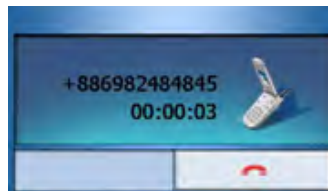

---

## Frequently Asked Questions

Q: Is my phone compatible with the p700?

A: Go to <http://global.acer.com/products/pda/index.htm> to check for compatibility.

Q: Why can't I send contact (vCard) information to my phone?

A: Your phone may not support the vCard format. Please check your phone's user guide or manufacturer website.

Q: Can I simultaneously connect the p700 to multiple Bluetooth devices?

A: No, the p700 does not support multiple connections to Bluetooth devices at the same time.

Q: Do I need to reconnect my phone to the p700 each time I want to make or receive calls?

A: Some phones will automatically reconnect with the p700, meaning you do not need to go through the connection process each time you want to use it to make or receive calls - Some phones only reconnect to the p700 if there is an incoming call or a call initiated from the mobile phone handset. There are even phones that will not reconnect and require a manual reconnection (refer to the **connecting your mobile phone using Bluetooth**). Check your phone's user manual for details about "auto-reconnection".

Q: Even though my phone can automatically reconnect to the p700, why do I have to manually reconnect it to my p700 when sending location or contact information?

A: Mobile phones require different profiles for different functions. Occasionally, you will have to manually reconnect your phone to the p700.

Q: I ended a call using my mobile phone, but the call is still active on my p700. Why?

A: Due to compatibility issues, some phones do not send the proper termination signals at the end of a call. To resolve this issue, end the call using your p700 by selecting .

Q: Why can't I use the p700 to make and receive phone calls?

A: Check the status of your p700 Bluetooth to make sure the p700 is connected to your mobile phone. Please refer to "How connecting your mobile phone using Bluetooth" and "How to check the Bluetooth status of your p700" for more details.

# Resetting the Acer p700 Series Portable Navigator

---

You may have to perform a reset if the device freezes (i.e., device no longer responds to the buttons on the screen). A soft reset allows your device to get a fresh start, similar to rebooting a computer. This will restart your device and adjust memory allocation. All records and entries are retained after a soft reset. GPS settings are also retained.

## Performing a soft reset

Hold the device securely; and Slide the Safe reset button to the left and slide it back to the right.



---

NOTE: Performing a soft reset will not clear the RAM in the unit.

---

## Performing a hard reset

If a soft reset does not correct the problem, you can then try a hard reset. Slide the power switch to the left and then slide it back to the right.



---

NOTE: Performing a hard reset will clear the RAM in the unit and reset the GPS of the unit.

---

## Loading the factory default settings

If you still encounter system errors even after soft and hard resetting the device, load the factory default settings to correct the error. These default settings have been selected to optimize your device's performance.

To load the factory default settings:

- 1 Tap System on the Main Menu panel.

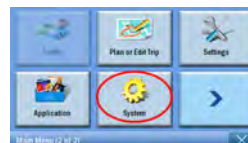

- 2 Tap Factory Default on the System panel.

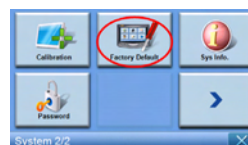

- 3 Tap Yes on the dialog box.

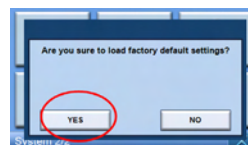

- 4 After the factory reset, reconfigure your device's user preferences.



---

NOTE: Performing a factory default will erase the RAM, reset the GPS and erase all the user/application data on the unit's flash storage. The data on the SD card will not be erased.

---

# Regulatory and safety notices

---

This device fully satisfies the requirements for CE marking when used in a residential, commercial or light industrial environment .

Underwriters Laboratories Inc. ("UL") has not tested the performance or reliability of the Global Positioning System ("GPS") hardware, operating software or other aspects of this product. UL has only tested for fire, shock or casualty hazards as outlined in UL's Standard(s) for Safety. UL Certification does not cover the performance or reliability of the GPS hardware and GPS operating software. UL MAKES NO REPRESENTATIONS, WARRANTIES OR CERTIFICATIONS WHATSOEVER REGARDING THE PERFORMANCE OR RELIABILITY OF ANY GPS-RELATED FUNCTIONS OF THIS PRODUCT. This appendix lists the general notices of your portable navigation device.

## FCC notice

This device has been tested and found to comply with the limits for a Class B digital device pursuant to Part 15 of the FCC rules. These limits are designed to provide reasonable protection against harmful interference in a residential installation. This device generates, uses, and can radiate radio frequency energy and, if not installed and used in accordance with the instructions, may cause harmful interference to radio communications.

However, there is no guarantee that interference will not occur in a particular installation. If this device does cause harmful interference to radio or television reception, which can be determined by turning the device off and on, the user is encouraged to try to correct the interference by one or more of the following measures:

Reorient or relocate the receiving antenna .

Increase the separation between the device and receiver.

Connect the device into an outlet on a circuit different from that to which the receiver is connected.

Consult the dealer or an experienced radio/television technician for help.

## Notice: Shielded cables

All connections to other computing devices must be made using shielded cables to maintain compliance with FCC regulations.



### Notice: Peripheral devices

Only peripherals (input/output devices, terminals, printers, etc.) certified to comply with the Class B limits may be attached to this equipment. Operation with non-certified peripherals is likely to result in interference to radio and TV reception.

### Caution

Changes or modifications not expressly approved by the manufacturer could void the user's authority, which is granted by the Federal Communications Commission, to operate this computer.

### Operation conditions

This device complies with Part 15 of the FCC Rules. Operation is subject to the following two conditions: (1) this device may not cause harmful interference, and (2) this device must accept any interference received, including interference that may cause undesired operation .

### Notice: Canadian users

This Class B digital apparatus complies with Canadian ICES-003.

### Remarque à l'intention des utilisateurs canadiens

Cet appareil numérique de la classe B est conforme a la norme NMB-003 du Canada.

### Declaration of Conformity for EU countries

Hereby, Acer, declares that this Acer p600 Series Travel Companion is in compliance with the essential requirements and other relevant provisions of Directive 1999/5/EC. (Please visit <http://global.acer.com/products/pda/reg-pda/index.htm> for complete documents.)

Compliant with Russian regulatory certification .



**ME61**

### LCD pixel statement

The LCD unit is produced with high-precision manufacturing techniques. Nevertheless, some pixels may occasionally misfire or appear as black or red dots. This has no effect on the recorded image and does not constitute a malfunction .

### Radio device regulatory notice

Note: Below regulatory information is for models with wireless LAN and/or Bluetooth only.

#### General

This product complies with the radio frequency and safety standards of any country or region in which it has been approved for wireless use. Depending on configurations, this product may or may not contain wireless radio devices (such as wireless LAN and / or Bluetooth modules). Below information is for products with such devices.

#### European Union (EU)

This device complies with the essential requirements of the European Council Directives listed below:

73/23/EEC Low Voltage Directive

EN 60950

89/336/EEC Electromagnetic Compatibility (EMC) Directive

EN 55022

EN 55024

EN 61000-3-2/-3

99/5/EC Radio & Telecommunications Terminal Equipment (R&TTE) Directive

Art.3.1a) EN 60950

Art.3.1b) EN 301 489 -1/-17

Art.3.2) EN 300 328-2

#### List of applicable countries

EU member states as of May 2004 are: Belgium, Denmark, Germany, Greece, Spain, France, Ireland, Italy, Luxembourg, the Netherlands, Austria, Portugal, Finland, Sweden, United Kingdom, Estonia, Latvia, Lithuania, Poland, Hungary, Czech Republic, Slovak Republic, Slovenia, Cyprus and Malta. Usage allowed in the countries of European Union, as well as Norway, Switzerland, Iceland and Liechtenstein. This device must be used in strict accordance with the regulations and constraints in the country of use. For further information, please contact local office in the country of use.

#### The FCC RF safety requirement

The radiated output power of the wireless LAN Mini PCI Card and Bluetooth card is far below the FCC radio frequency exposure limits. Nevertheless, the Acer p600 Series Travel Companion shall be used in such a manner that the potential for human contact during normal operation is minimized as follows:

An improper installation or unauthorized use may cause harmful interference to radio communications. Also any tampering of the internal antenna will void the FCC certification and your warranty.

To comply with FCC RF exposure compliance requirements, a separation distance of at least 20 cm (8 inches) must be maintained between this device and any other antennas or transmitters.

### **Canada — Low-power license-exempt radio communication devices (RSS-210)**

Common information

Operation is subject to the following two conditions:

1. This device may not cause interference, and
2. This device must accept any interference, including interference that may cause undesired operation of the device.

Operation in 2.4 GHz band

To prevent radio interference to the licensed service, this device is intended to be operated indoors and installed outdoors is subject to licensing.

### **Exposure of humans to RF fields (RSS-102)**

The Acer p700 Series Portable Navigator employs low gain integral antennas that do not emit RF field in excess of Health Canada limits for the general population; consult Safety Code 6, obtainable from Health Canada's website at [www.hc-sc.gc.ca/rpb](http://www.hc-sc.gc.ca/rpb).

# FAQs

This section lists down frequently asked questions that may arise during the use of your Acer p700 Series Portable Navigator, and gives easy answers and solutions to these questions.

Aspect	Question	Answer
Audio	Why is there no sound coming from the device?	<ul style="list-style-type: none"> <li>• If the earphones are plugged into the device, the speaker is automatically shut off. Disconnect the earphones.</li> <li>• Check that the device's volume settings is not muted. In the System panel, tap <b>Volume</b>.</li> <li>• Check that the volume control is not at its lowest setting.</li> </ul>
Touch screen	Why is the touch screen not responding to my finger taps?	The screen may have lost its calibration. Recalibrate the screen.
Multimedia mode	Why can't I view my picture files?	You may be trying to view an image that is not supported by Photo. Go to "Photo viewer" on page 15 for a list of supported image formats.
Navigation mode	Why is it that sometimes my device takes longer than 5 minutes to get a GPS fix?	If the previous GPS fix position was more than 500 km or 12 hours apart from your current position and time, it will take significantly longer than the standard TTFF time to get a GPS fix. This is due to the nature of the GPS algorithm and rotational velocity between the satellites and planet Earth, and deemed normal and is not the fault of your Acer p700 Series Portable Navigator device.

---

Aspect	Question	Answer
System information and performance	How do I check the OS version of my device?	View the device's OS version and other technical specifications. In the System panel, tap <b>Sys Info</b> .
	How do I restore the system back to its default factory settings?	Users can perform this task by using the Factory Reset button on the System Info screen. Go to "Loading the factory default settings" on page 43 for instructions.
	What should I do if the system stops functioning normally?	Perform a soft reset on the device. Go to "Performing a soft reset" on page 42 for instructions.
Power	I couldn't turn on the device.	The battery power may be depleted. Recharge the device. Go to "Recharging the Acer p700 Series Portable Navigator" on page 7 for instructions.

---

# Customer support

---

## Technical assistance

If you encounter a problem with your Acer p700 Series Portable Navigator, review the following first:

- "Resetting the Acer p700 Series Portable Navigator" on page 42
- "FAQs" on page 45
- Latest Acer p700 Series Portable Navigator User Guide on your regional Acer web site. Go to <http://global.acer.com/support/>.

If the problem still persists, you will need technical assistance. Refer to the <http://global.acer.com/about/webmaster.htm/> web site for information on how and where to contact the Acer Service Centers available in your area.

## Product warranty

Refer to the Acer p700 Series Portable Navigator Warranty Booklet (Manufacture option) for details on the warranty coverage of your Acer p700 Series Portable Navigator.

---

# System specifications

---

This chapter lists the features and operating specifications of the Acer p700 Series Portable Navigator.

## Hardware features

Aspect	Description
Processor	<ul style="list-style-type: none"> <li>• Samsung S3C2412A26 266 MHz application processor</li> </ul>
GPS chipset	<ul style="list-style-type: none"> <li>• SiRF Star III AL chipset and firmware solution</li> </ul>
Memory	<ul style="list-style-type: none"> <li>• 64 MB SDRAM for system memory</li> <li>• 64 MB onboard Flash memory ( for operating system and embedded applications ); Model with 2 GB Flash memory is also available</li> </ul>
Power	<ul style="list-style-type: none"> <li>• High-density rechargeable 1100 mAh Lithium Ion battery               <ul style="list-style-type: none"> <li>– 3.5 hours charging time from empty to full capacity</li> </ul> </li> <li>• Recharging options               <ul style="list-style-type: none"> <li>– Wall charger (p730/p760/p780)</li> <li>– Car charger</li> <li>– USB cable</li> </ul> </li> <li>• Power status LED indicator</li> </ul>
Display	<ul style="list-style-type: none"> <li>• 4 inch screen for a wider viewing angle</li> </ul>
Audio	<ul style="list-style-type: none"> <li>• 1 W built-in speaker</li> <li>• 3.5 mm stereo earphone jack</li> </ul>
Connectivity	<ul style="list-style-type: none"> <li>• Mini USB 1.1 client (2.0 optional)</li> <li>• SD / MMC slot (Supports up to 2 GB)</li> </ul>
Hardware command interface	<ul style="list-style-type: none"> <li>• Volume control hot keys</li> <li>• Main Menu / Navigation hot key</li> </ul>

### Design and ergonomics

Aspect	Description
Compact and lightweight	<ul style="list-style-type: none"><li>• Dimensions (L x W x H): 123 x 96.42 x 24.02 mm</li><li>• Weight: 240g</li></ul>
User-friendly interface	<ul style="list-style-type: none"><li>• Acer p700 Series Portable Navigator<ul style="list-style-type: none"><li>– Quick launch hot keys for Main Menu and Navigation screens</li><li>– Control hot keys for volume level</li><li>– Touch sensitive screen</li></ul></li><li>• Car mount<ul style="list-style-type: none"><li>– Windshield Mount</li><li>– Firm grip suction cup provides a steady vibration-free support</li><li>– Swiveling mechanism and axial rod allows for multi angle adjustment for optimum viewing position</li></ul></li><li>• Software<ul style="list-style-type: none"><li>– Multi-language user interface options</li><li>– Contacts integration with navigation function</li><li>– System configuration based on individual user preferences</li></ul></li></ul>
Power-saving options	<ul style="list-style-type: none"><li>• Auto-off function for touch screen backlight</li></ul>
Mobile design	<ul style="list-style-type: none"><li>• Suction-based car mount facilitates multi-vehicle usage</li><li>• Compact and lightweight body makes it easy for users to carry anywhere</li><li>• On-the-road recharging via car charger</li><li>• Simple, out-of-the-box operation: Mount, dock, and you're ready the go. No hassle with screws and cables.</li></ul>
Entertainment function	Pre-loaded software image files (Photo)



---

Aspect	Description
Bundled peripherals	<ul style="list-style-type: none"> <li>• Car mount</li> <li>• Car holder</li> <li>• Car charger</li> <li>• Wall charger (Manufacture option)</li> <li>• USB cable</li> </ul>
Accessory options	<ul style="list-style-type: none"> <li>• External TMC module with antenna</li> </ul>

## Environmental specifications

Aspect	Description
Temperature	Operating: -30°C to 60°C Storage: -30°C to 70°C
Relative humidity (non-condensing )	Operating: 20 % to 90 % RH Non-operating: < 20 % RH and >90 % RH